

POLYLAB (EPT)

@ Ecole Polytechnique de Thiès

Partnership scientifica tra Africa occidentale e Italia / Conference

September 9th 2022 / online

Pr Ibrahima Gueye

igueye@ept.sn

Polylab's Manager

The Polylab

- *Fablab located at the Polytechnic School of Thiès since December 2015*
- *R&D, Prototyping, Learning.*
- *Other activities*
 - *Training / Apprenticeship / Capacity building*

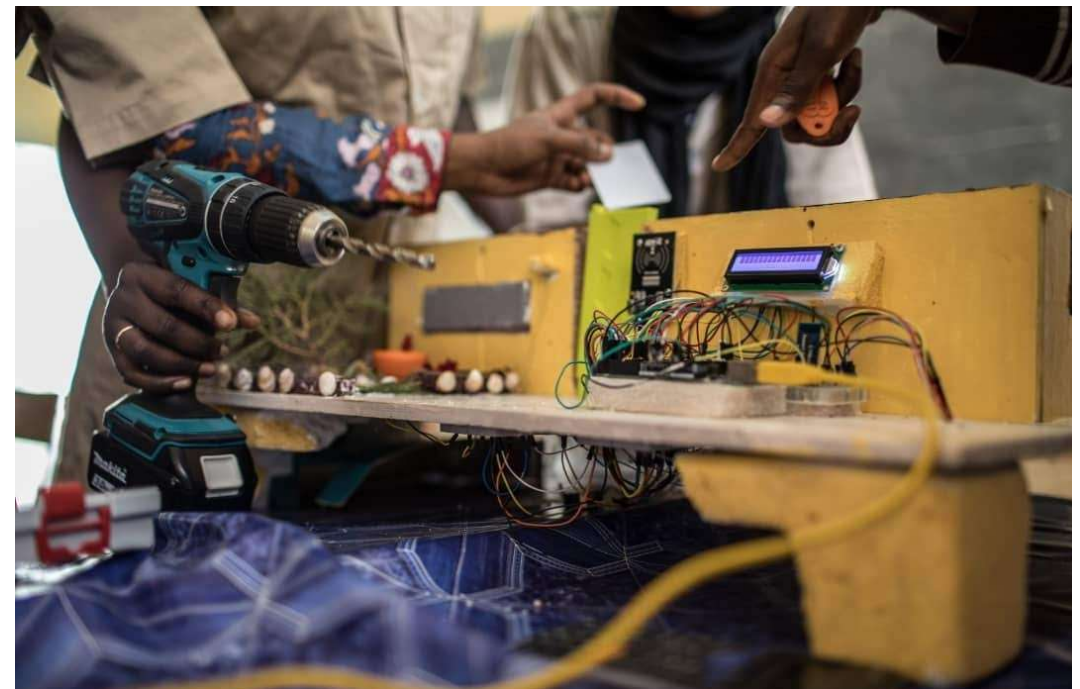
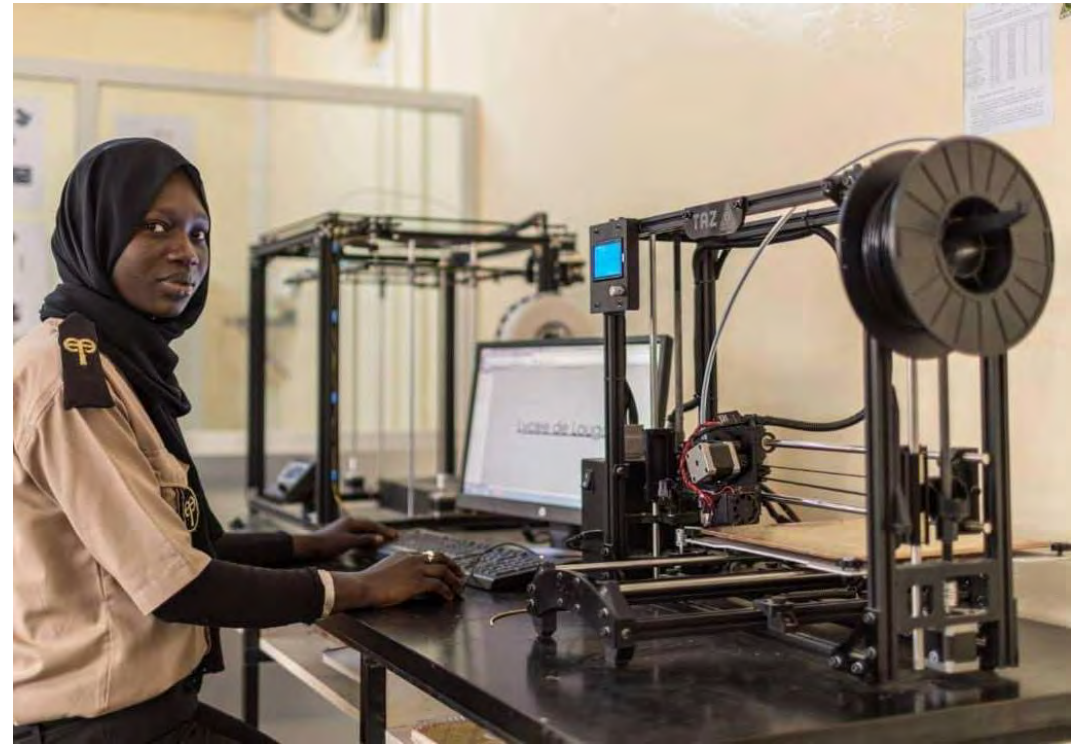

Activities

- *Training / Capacity building*
 - *Prototyping*
 - *3D printing, Computer Aided Design*
 - *CNC cutting, Laser cutting*
 - *Electronics, Embedded Systems and IoT*
 - *Programming*
- *Various projects designed and executed at Polylab*

3D printing at the Polylab

- *FDM: classic raw materials (PLA, ABS, Flexible, Bamboo, Copper, etc). Prototypes de Prothèses pour handicapés moteur*
 - ❖ *Hearing Aid Components: Hearing Aids for the Elderly*
 - ❖ *Components of an artificial respirator*
 - ❖ *Various components for prototypes and demonstrators in aeronautics, IoT & various monitoring; Leg prostheses, Masks, visors, boxes, etc.;*
- *Biocompatible raw materials not very accessible at our level.*

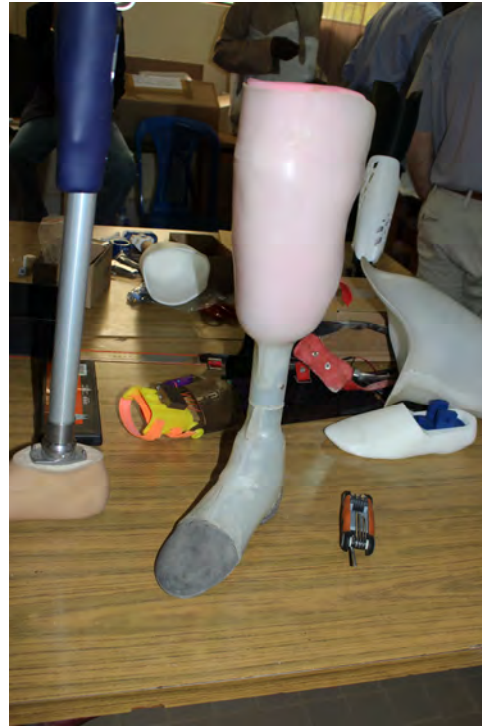
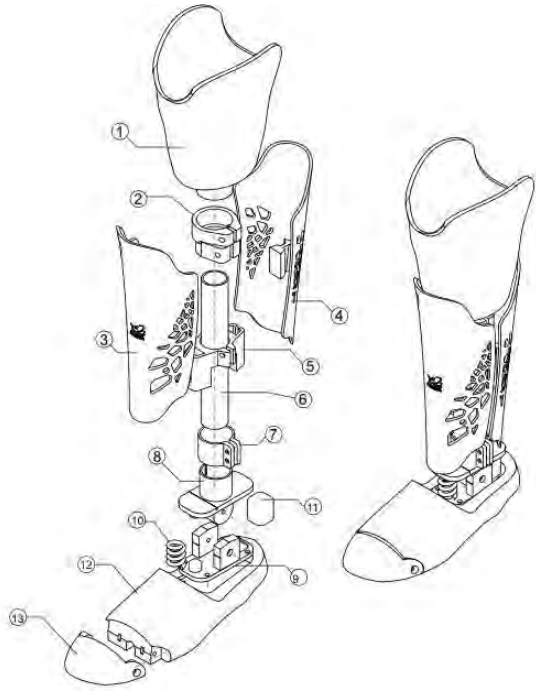



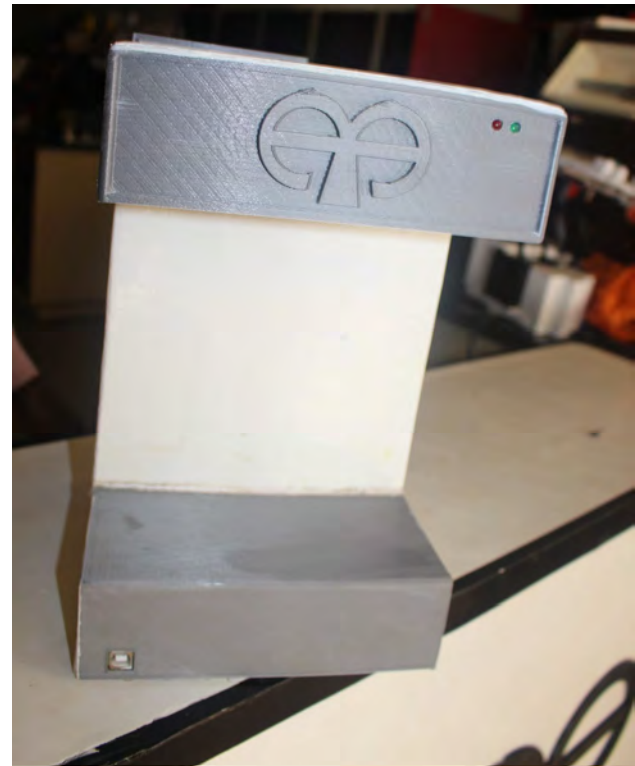



savon

EAU



savon

EAU



savon

EAU



Raspberry pi (passerelle)
centralise et met au bon format
les données collectées
(**node-red**)



AWS RDS (Base de données)



visualisation (django + Dash)

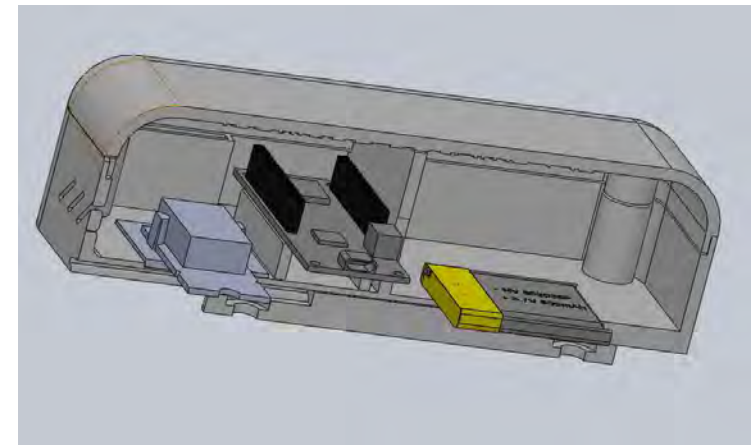
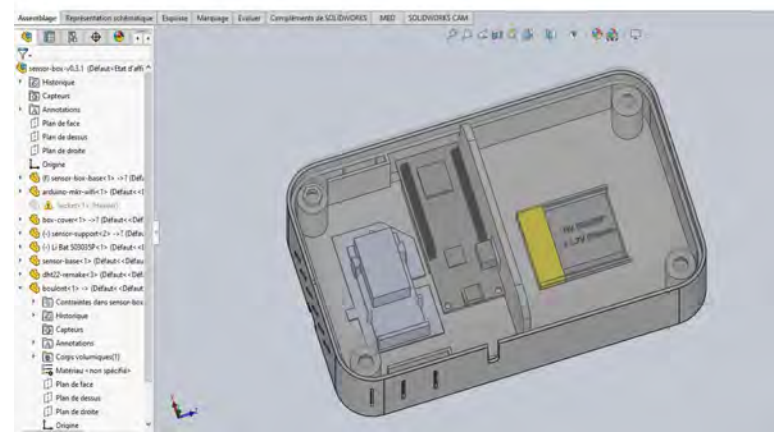

*Thank you for your
attention*